



JOC303XD5 Series

Rev.A.1.0

DESCRIPTION:

The JOC303XD5 series combine an AlGaAs infrared emitting diode as the emitter which is optically coupled to a monolithic silicon zero-cross photo triac in a plastic DIP5 and SMD package with different lead forming options. The products are widely used in solenoid/valve controls, lighting controls, motor controls, temperature controls, static AC power switches, solid state relays, interfacing microprocessors up to 120 V_{AC} peripherals.

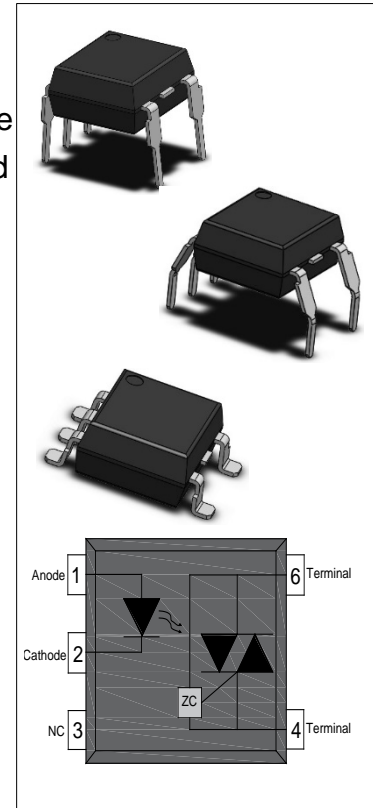

MAIN FEATURES

- High isolation 5000 VRMS
- DC input with zero-cross photo triac output
- Operating temperature range -55 °C to 100 °C
- REACH & RoHS compliance
- HBM: H3A ; MM: M4
- CQC approved
- VDE approved
- UL approved

ABSOLUTE MAXIMUM RATINGS (Temperature=25°C)

Parameter		Symbol	Value	Unit
Input	Forward Current	I _F	60	mA
	Reverse Voltage	V _R	6	V
	Junction Temperature	T _j	125	°C
	Input Power Dissipation	P _I	100	mW
	Power Dissipation Derating (T _a ≥ 25°C)	Δ P _D /°C	-1.33	mW/°C
Output	Off-state Output Terminal Voltage	V _{OFF}	250	V
	Peak On-state Current (100μs pulse, 120 pps)	I _{TP}	2	A
	On-state RMS Current	I _{T(RMS)}	100	mA
	Peak Repetitive Surge Current (P _W =10 ms)	I _{TSM}	1	A
	Junction Temperature	T _j	125	°C
	Output Power Dissipation	P _O	250	mW

	Power Dissipation Derating ($T_a \geq 25^\circ\text{C}$)	$\Delta P_D / ^\circ\text{C}$	-3.33	mW/ $^\circ\text{C}$
Total Power Dissipation		P_{tot}	350	mW
Isolation Voltage		V_{iso}	5000 ^①	V _{rms}
Operating Temperature		T_{opr}	-55~100	$^\circ\text{C}$
Storage Temperature		T_{stg}	-55~125	$^\circ\text{C}$
Soldering Temperature		T_{sol}	260 ^②	$^\circ\text{C}$

NOTE1: AC for 1minute, R.H.=40~60%

NOTE2: For 10 seconds

ELECTRICAL CHARACTERISTICS (Temperature=25 $^\circ\text{C}$)

Parameter		Symbol	Condition	Min.	Typ.	Max.	Unit
Input	Forward Voltage	V_F	$I_F=10\text{mA}$	-	1.27	2.2	V
	Reverse Current	I_R	$V_R=6\text{V}$	-	-	1	μA
	Input Capacitance	C_{in}	$V=0, f=1\text{kHz}$	-	10	-	pF
Output	Peak Off-state Current, Either Direction	I_{OFF}	$V_{\text{OFF}}=250\text{V}, I_F=0$	-	-	100 ^③	nA
	Peak On-state Voltage, Either Direction	V_{TM}	$I_{\text{TM}}=100\text{mA}$	-	1.7	2.5	V
	Critical Rate of Rise of Off-state voltage	dV/dt	$V_{\text{PEAK}}=250\text{V}, I_F=0$	1000 ^④	-	-	V/ μs
Transfer Characteristics	LED Trigger Current	JOC3031D5	Terminal Voltage=3V $I_{\text{TM}}=100\text{mA}$	-	-	15	mA
		JOC3032D5		-	-	10	
		JOC3033D5		-	-	5	
	Holding Current	I_H	$I_{\text{TM}}=2\text{mA}, I_F=\text{Rated } I_{\text{FT}}$	-	250	-	μA
	Isolation Resistance	R_{ISO}	DC500V 40~60%R.H.	10^{12}	10^{14}	-	Ω
	Floating Capacitance	C_{IO}	$V=0, f=1\text{MHz}$	-	10	-	pF
Response Time	t_{on}	$V_D=6\text{V}, R_L=100\Omega, I_F=20\text{mA}$	-	15	50	μs	
Zero-crossing Characteristics	Inhibit Voltage	V_{IH}	$I_F=\text{Rated } I_{\text{FT}}$	-	-	20	V
	Leakage in Inhibited State	$I_{\text{OFF}2}$	$I_F=\text{Rated } I_{\text{FT}}, V_{\text{OFF}}=\text{Rated } V_{\text{OFF}}$	-	-	1	mA

NOTE3: Test voltage must be applied within dV/dt ratings.

NOTE4: Refer to Fig.14 & Fig.15

ORDERING AND MARKING INFORMATION

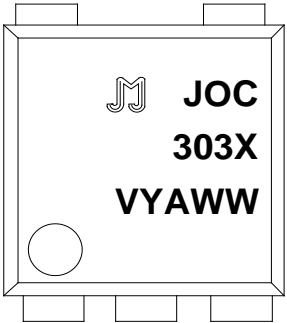
MARKING INFORMATION			
		<p>JOC : Company Abbr. 303X : Part Number & Rank V : VDE Option Y : Fiscal Year A : Manufacturing Code WW : Work Week</p>	
ORDERING INFORMATION			
JOC303XD5(Y)(Z)-GV			
<p>JOC – Company Abbr. 303X – Part Number (1/2/3) D5 – DIP5 Package Y – Lead Form Option (M/SL/None) Z – Tape and Reel Option (T1) G – Green Option (G or None) V – VDE Option (V or None)</p>			
Packing Quantity			
Option	Quantity	Quantity – Inner box	Quantity –Outer box
None	65 Units/Tube	32 Tubes/Inner box	10 Inner box/Outer box =20.8k Units
M	65 Units/Tube	32 Tubes/Inner box	10 Inner box/Outer box =20.8k Units
SL(T1)	1000 Units/Reel	3 Reels/Inner box	5 Inner box/Outer box =15k Units

Characteristics Curves

FIG.1: Forward Current vs. Ambient Temperature

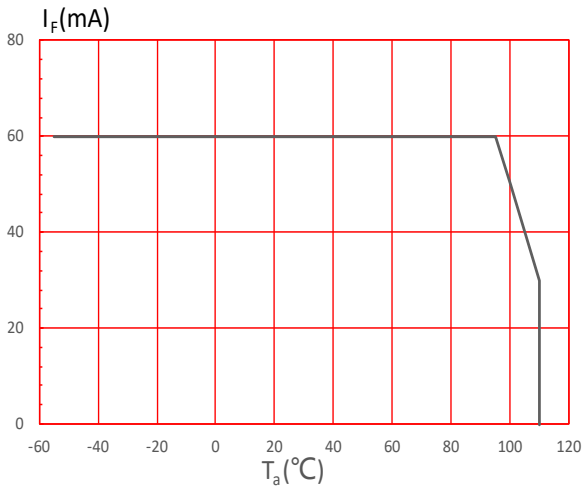

FIG.2: On-state Terminal Current vs. Ambient Temperature

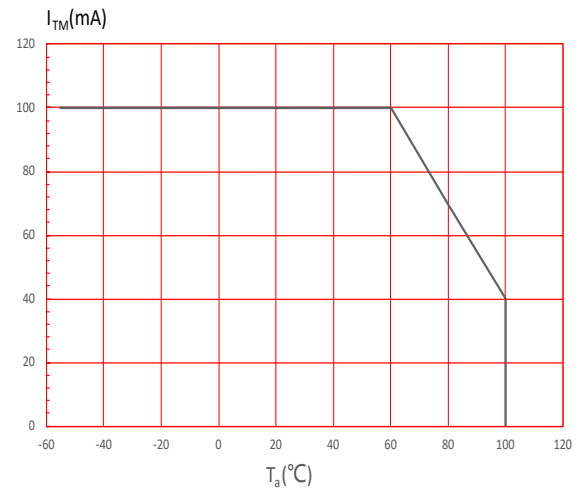

FIG.3: Forward Current vs. Forward Voltage

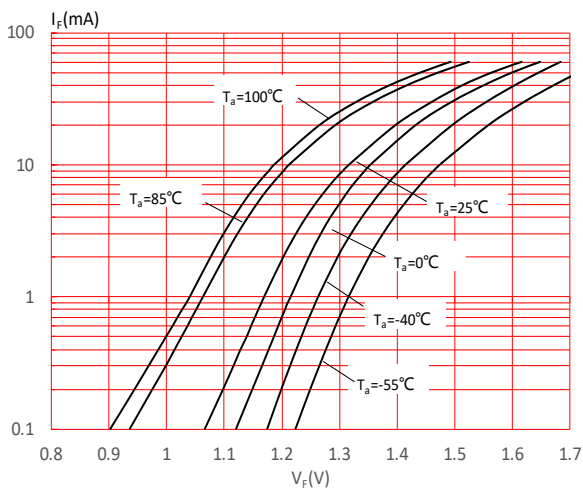

FIG.4: Normalized Off-state Terminal Current vs. Ambient Temperature

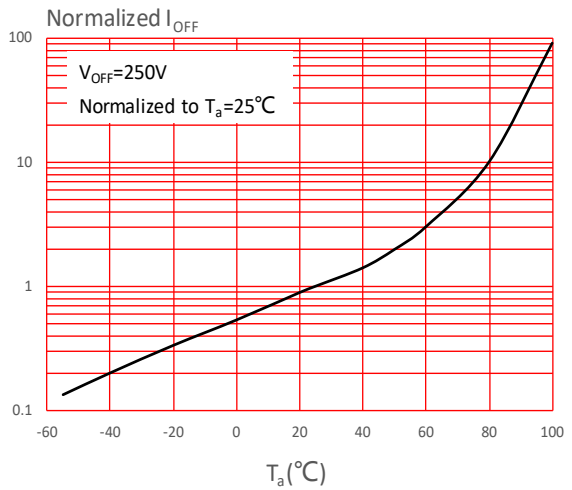

FIG.5: Normalized Off-state Terminal Voltage vs. Ambient Temperature

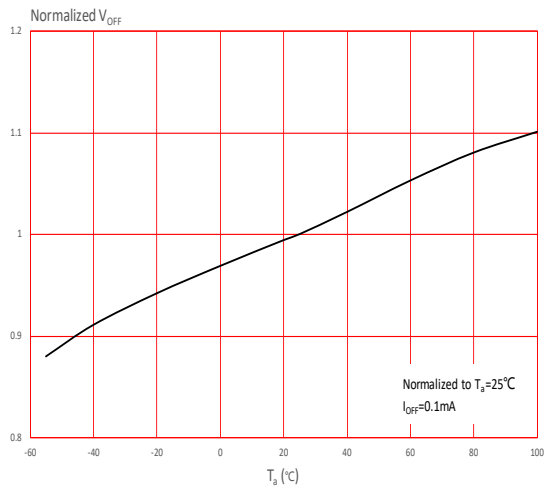

FIG.6: Normalized Trigger Current vs. Ambient Temperature

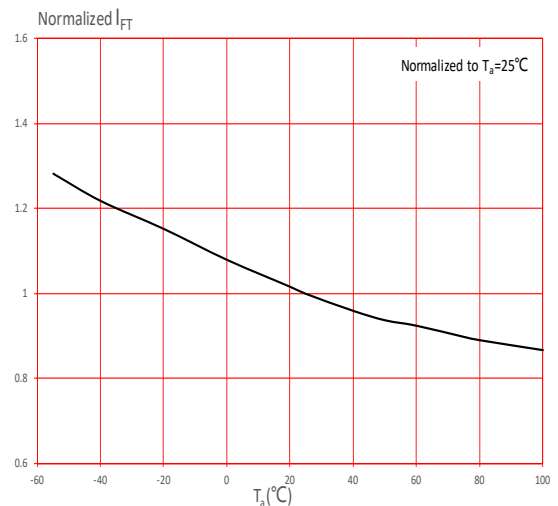

FIG.7: Normalized On-state Terminal Voltage vs. Ambient Temperature

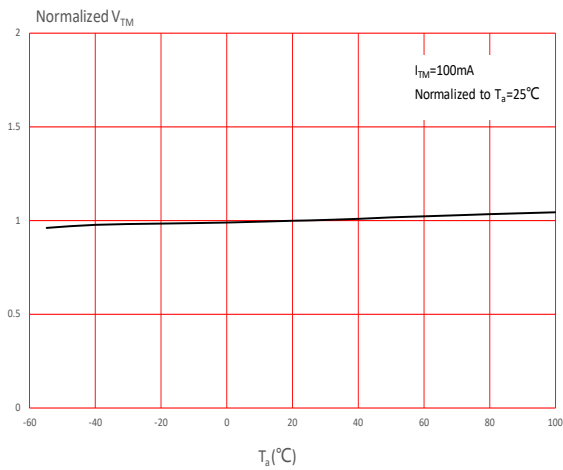

FIG.8: On-state Terminal Voltage vs. On-state Terminal Current

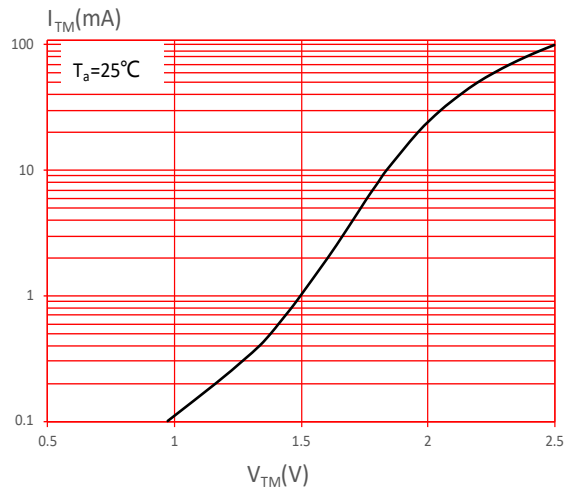

FIG.9: Normalized Holding Current vs. Ambient Temperature

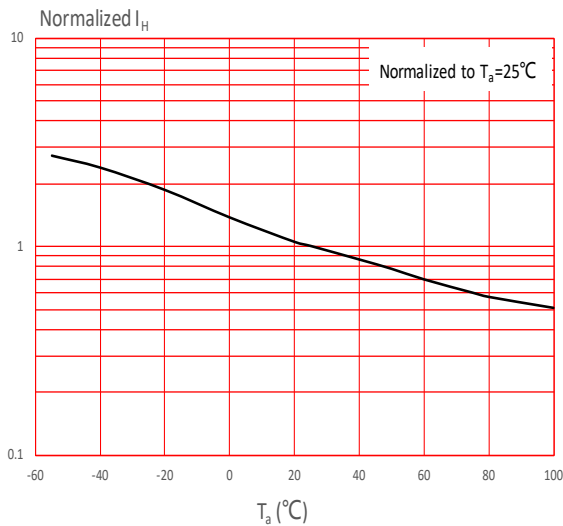

FIG.10: Normalized Leakage in Inhibit State vs. Ambient Temperature

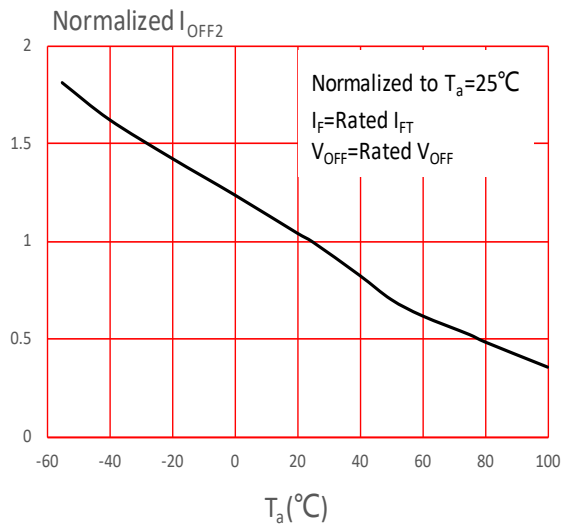
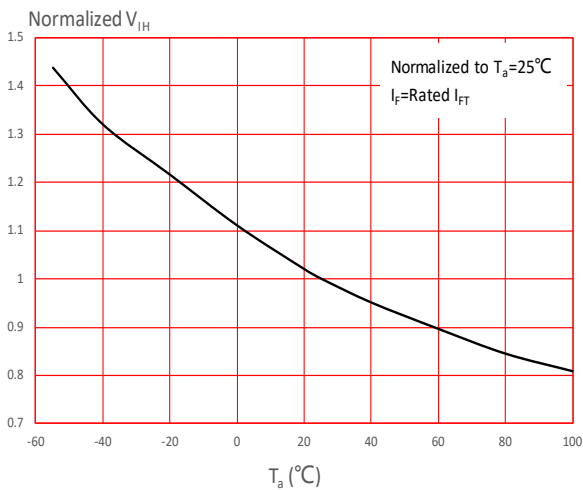

FIG.11: Normalized Inhibit Voltage vs. Ambient Temperature



TEST CIRCUITS

FIG.12: Test Circuits of Turn On Time

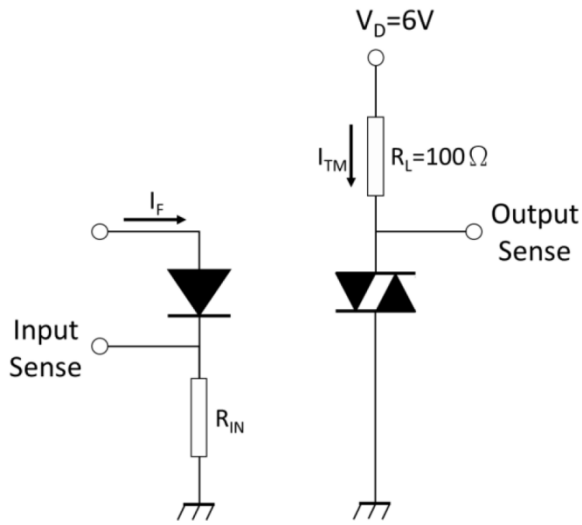

FIG.13: Waveforms of Turn On Time



Fig.14: Test Circuits of dV/dt

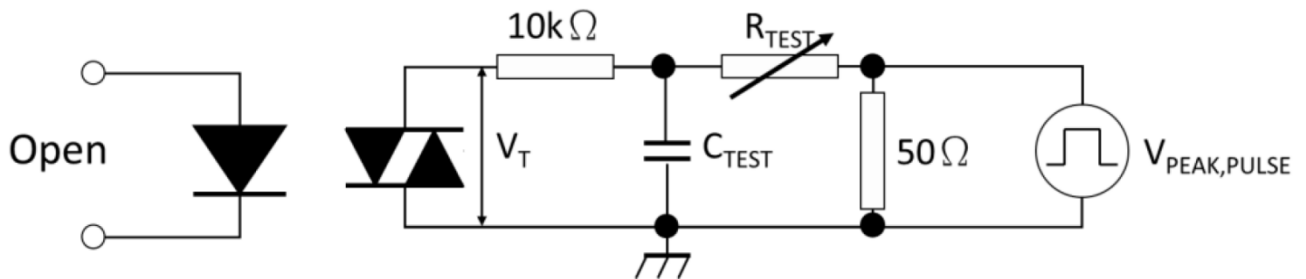
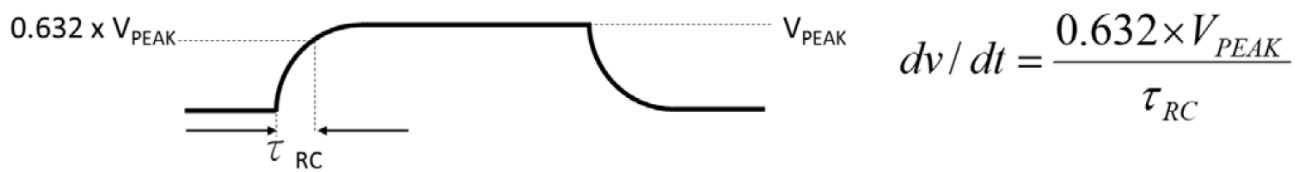
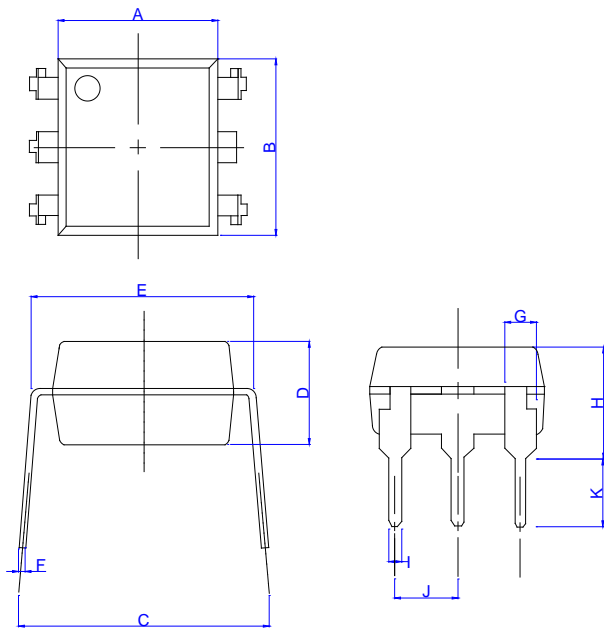

Fig.15: Waveforms of dV/dt



Package Dimension (Unit: mm)

Standard DIP Type:



Ref.	Dimensions					
	Millimeters			Inches		
	Min.	Typ.	Max.	Min.	Typ.	Max.
A	6.30		6.70	0.249		0.265
B	6.92		7.32	0.274		0.289
C	7.62		9.50	0.301		0.375
D	3.30		3.70	0.130		0.146
E	7.32		7.92	0.289		0.313
F		0.25			0.010	
G	1.20		1.40	0.047		0.055
H	4.20		4.80	0.166		0.190
I		0.50			0.020	
J		2.54			0.100	
K		2.80			0.111	

Option M Type:

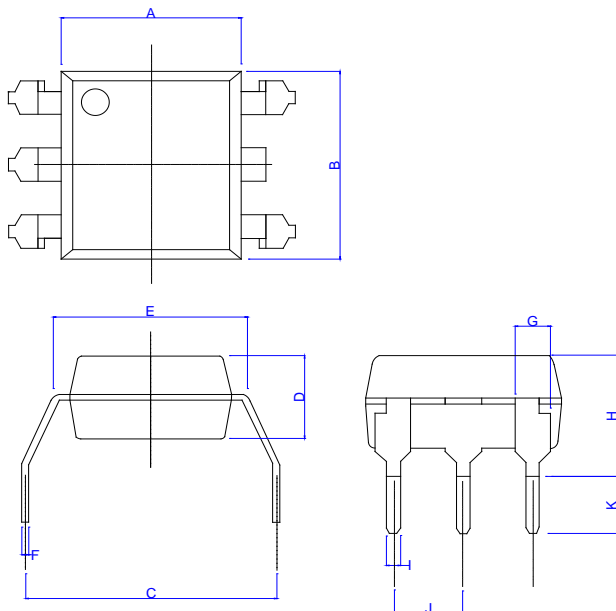

Ref.	Dimensions					
	Millimeters			Inches		
	Min.	Typ.	Max.	Min.	Typ.	Max.
A	6.30		6.70	0.249		0.265
B	6.92		7.32	0.274		0.289
C	9.86		10.46	0.390		0.413
D	3.30		3.70	0.130		0.146
E	7.32		7.92	0.289		0.313
F		0.25			0.010	
G	1.20		1.40	0.047		0.055
H	4.28		4.88	0.169		0.193
I		0.50			0.020	
J		2.54			0.100	
K	2.20			0.087		

Option SL Type:

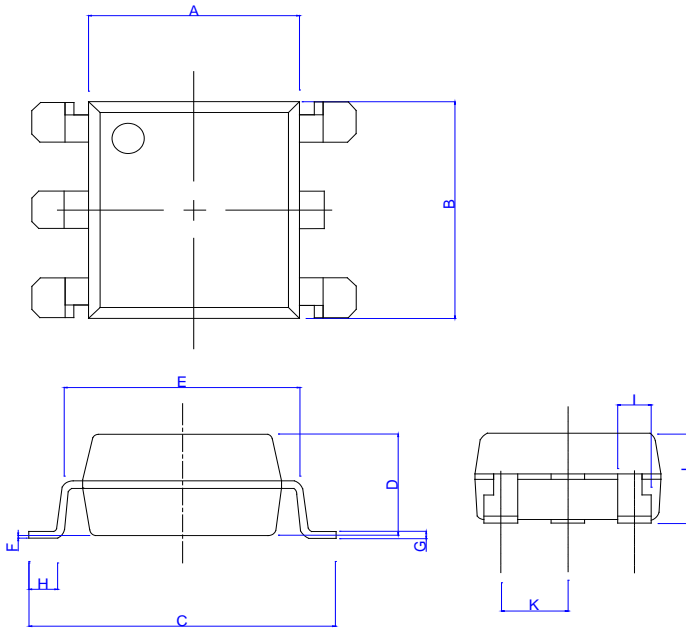

Ref.	Dimensions					
	Millimeters			Inches		
	Min.	Typ.	Max.	Min.	Typ.	Max.
A	6.30		6.70	0.249		0.265
B	6.92		7.32	0.274		0.289
C	9.85		10.45	0.389		0.413
D	3.30		3.70	0.130		0.146
E	7.32		7.92	0.289		0.313
F		0.10			0.004	
G		0.25			0.010	
H		0.80			0.032	
I	1.20		1.40	0.047		0.055
J	3.30		3.90	0.130		0.154
K		2.54			0.100	

RECOMMENDED SOLDER MASK (Dimensions in mm unless otherwise stated)

Option SL

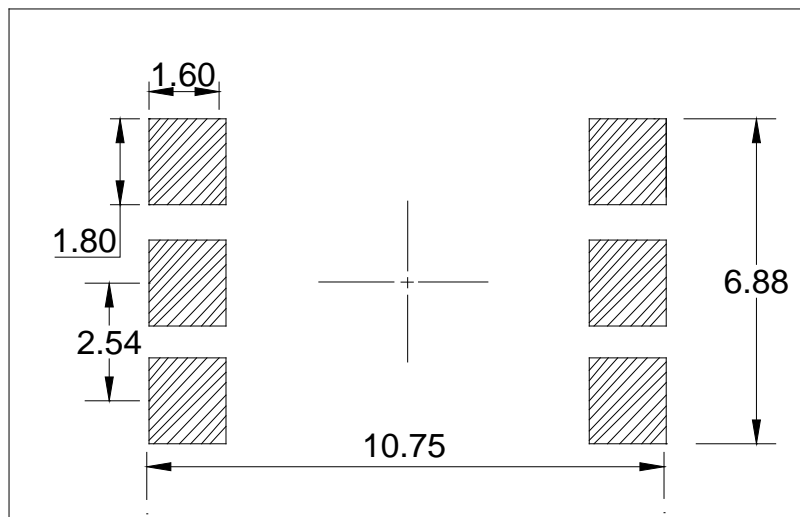

TUBE SPECIFICATIONS (Dimensions in mm unless otherwise stated)

Standard DIP

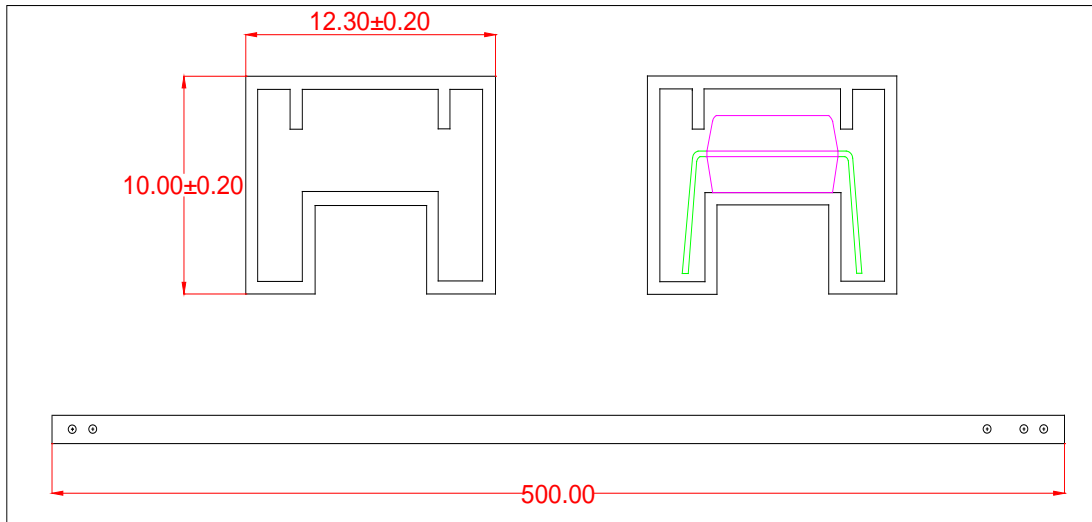

Option M

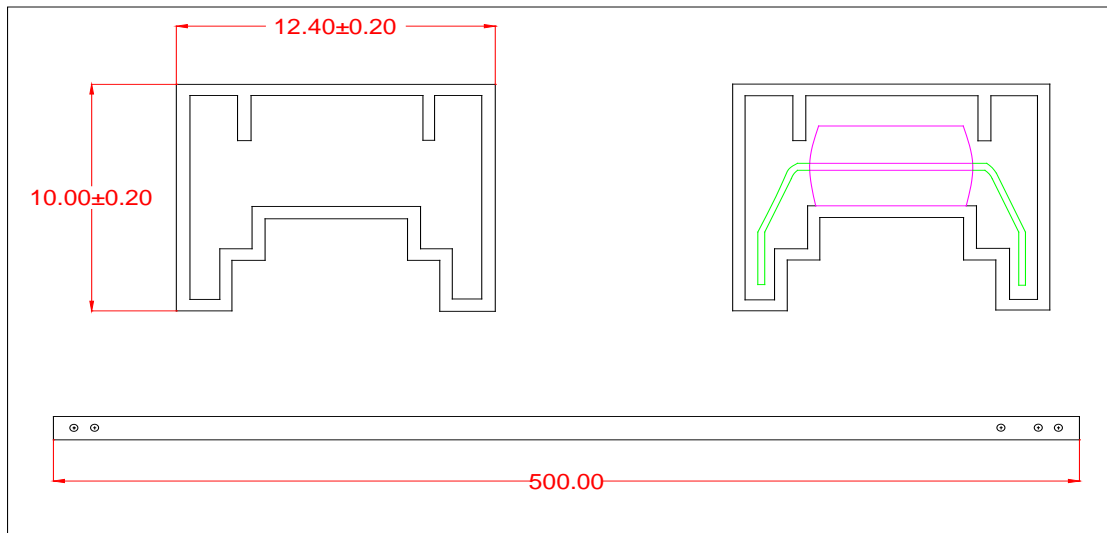

CARRIER TAPE SPECIFICATIONS (Dimensions in mm unless otherwise stated)

Option SL(T1)

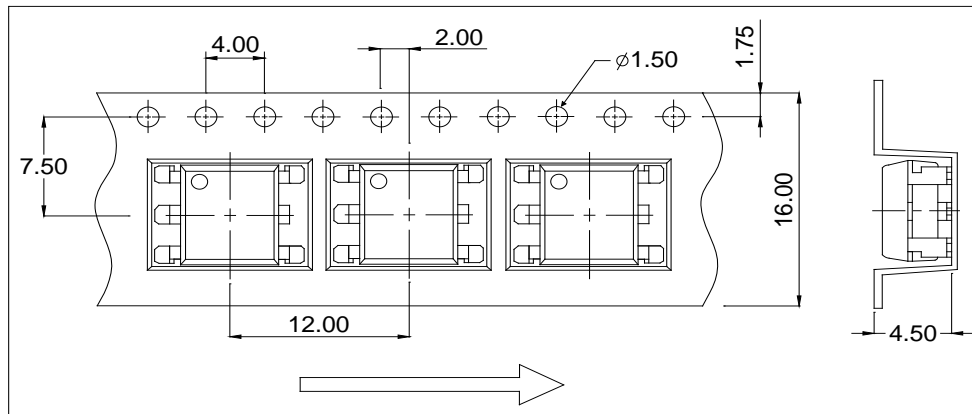

REEL SPECIFICATIONS (Dimensions in mm unless otherwise stated)

Option SL

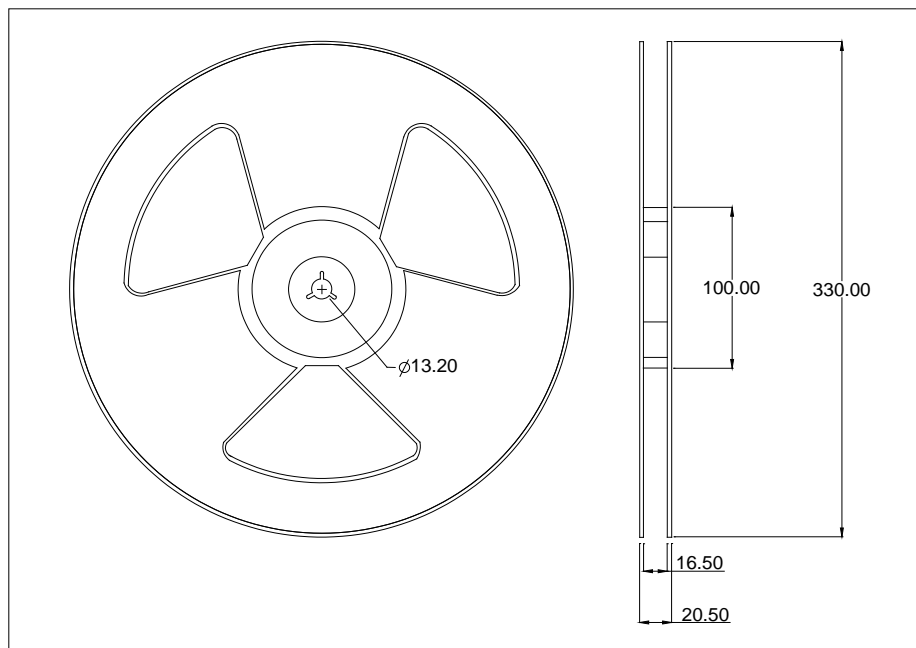

REFLOW INFORMATION

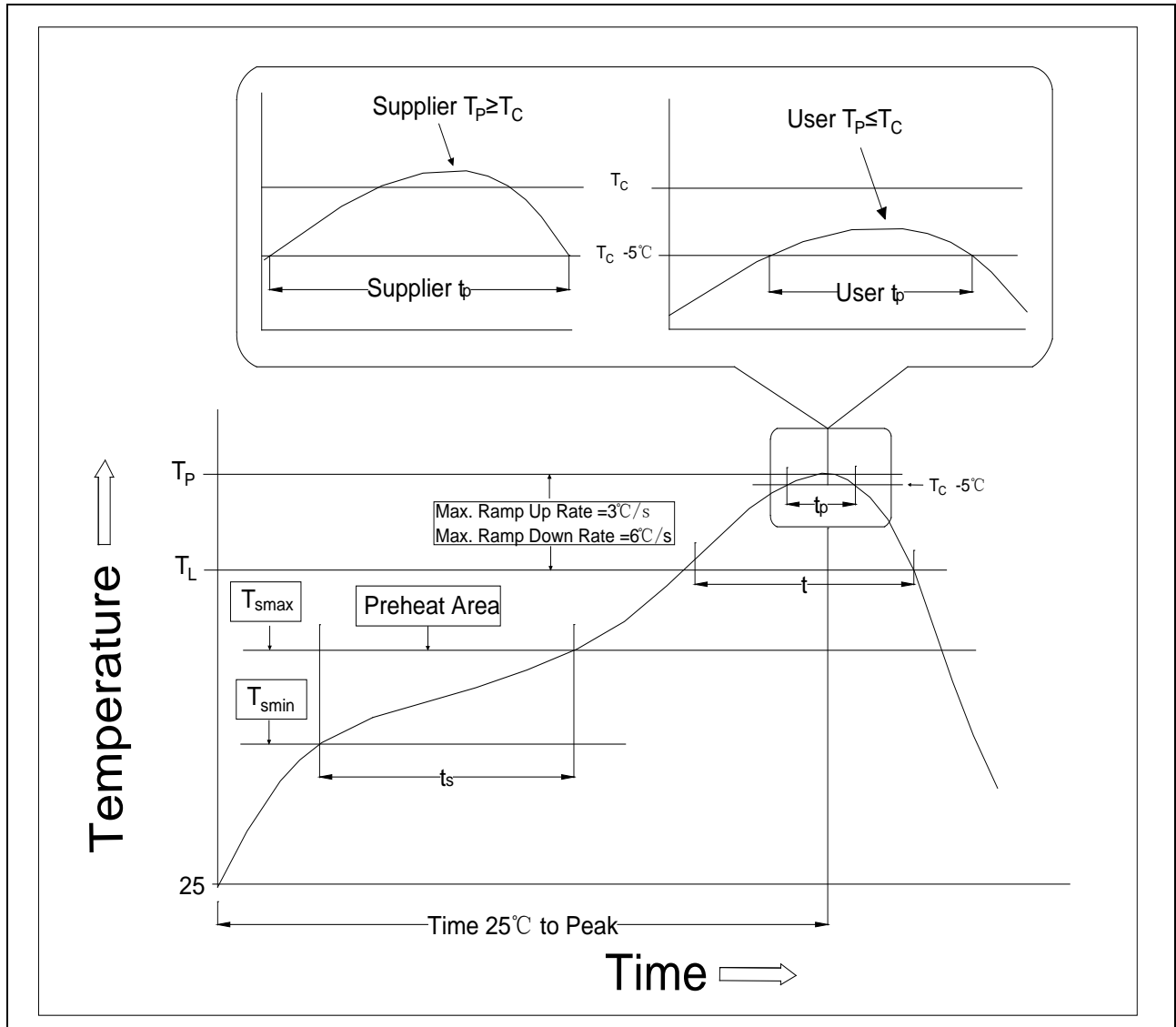

Profile Feature	Sn-Pb Assembly Profile	Pb-Free Assembly Profile
Temperature Min. (T _{smin})	100	150°C
Temperature Max. (T _{smax})	150	200°C
Time (t _s) from (T _{smin} to T _{smax})	60-120 seconds	60-120 seconds
Ramp-up Rate (t _L to t _P)	3°C/second max.	3°C/second max.
Liquidus Temperature (T _L)	183°C	217°C
Time (t _L) Maintained Above (T _L)	60-150 seconds	60-150 seconds
Peak Body Package Temperature	235°C+0°C/-5°C	260°C+0°C/-5°C
Time (t _P) within 5°C of 260°C	20 seconds	30 seconds
Ramp-down Rate (T _P to T _L)	6°C/second max.	6°C/second max.
Time 25°C to Peak Temperature	6 minutes max.	8 minutes max.

WAVE SOLDERING

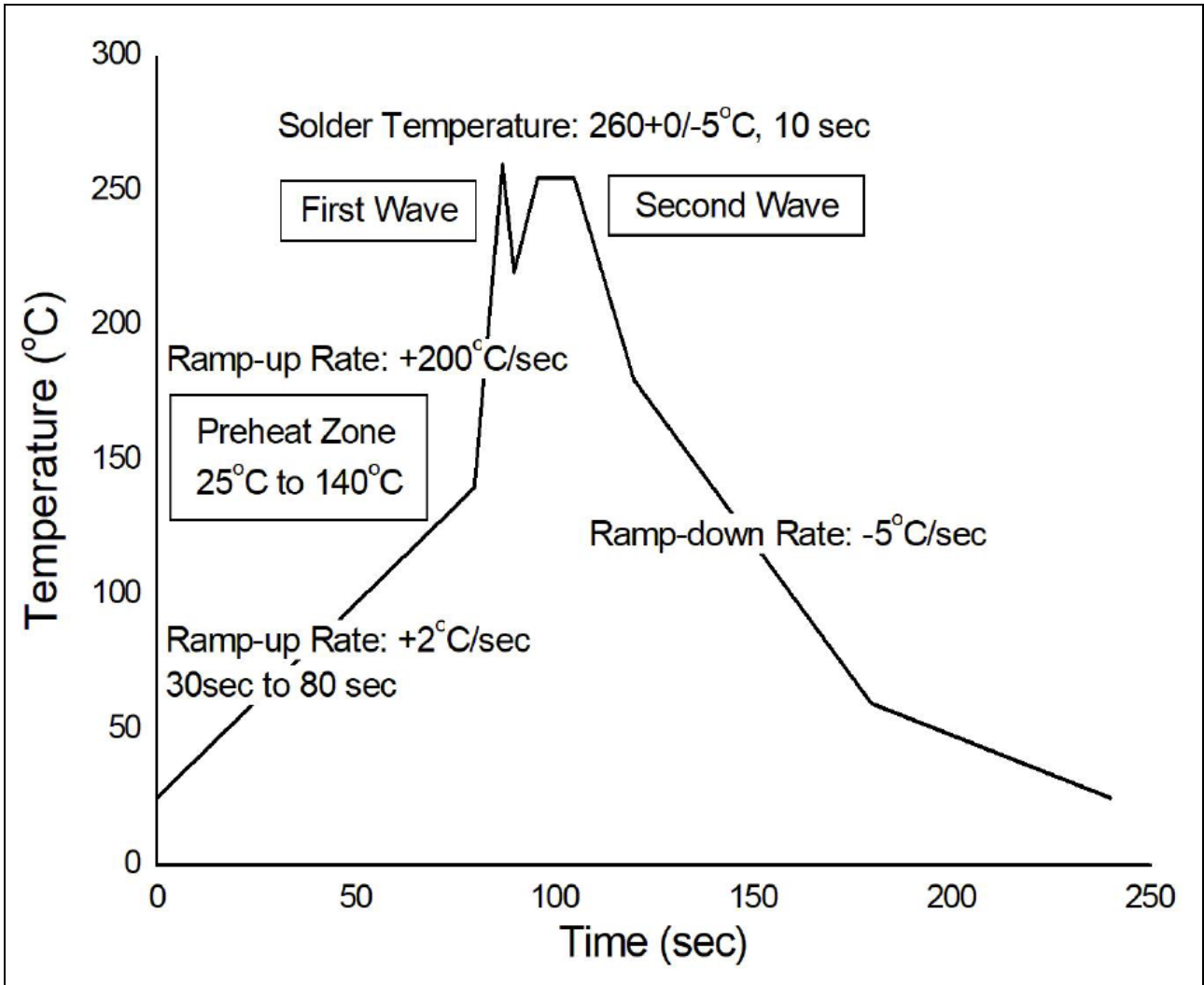

HAND SOLDERING BY SOLDERING IRON

Soldering Temperature	360±5°C
Soldering Time	3s max.

Information furnished in this document is believed to be accurate and reliable. However, Jiangsu JieJie Microelectronics Co., Ltd. assumes no responsibility for the consequences of use without consideration for such information nor use beyond it. Information mentioned in this document is subject to change without notice, apart from that when an agreement is signed, Jiangsu JieJie complies with the agreement.

Products and information provided in this document have no infringement of patents. Jiangsu JieJie assumes no responsibility for any infringement of other rights of third parties which may result from the use of such products and information. This document supersedes and replaces all information previously supplied.

 is a registered trademark of Jiangsu JieJie Microelectronics Co., Ltd.
Copyright © 2025 Jiangsu JieJie Microelectronics Co., Ltd. All rights reserved.